

CANET-8E-U

High-Performance Eight-Channel Ethernet to CAN Converter

UM01010101 V1.03 Date: 2020/11/17

Product User Manual



Category	Contents
Keywords	CAN-bus Ethernet Eight-Channel CAN
Description	The CANET-8E-U high-performance eight-channel Ethernet to CAN converter is a derivative product on the new generation hardware and software platform, which improves the communication flow and system reliability.

Revision History

Version	Date	Description
V0.90	August 23, 2017	Created
V1.00	August 29, 2017	Improved the document
V1.01	October 9, 2017	Fixed bugs
V1.02	March 12, 2019	Updated the document header and footer and "Sales and Service Network" content and added the "Disclaimer" content
V1.03	November 17, 2020	Added 1000M network port pin definition

Contents

1. Functions	1
1.1 Overview	1
1.2 Features	2
1.2.1 Powerful hardware	2
1.2.2 Perfect functions	2
1.3 Specifications	3
1.3.1 LAN	3
1.3.2 CAN	3
1.3.3 Software Features	3
1.3.4 EMC Characteristics	3
1.3.5 Electrical Parameters	3
1.4 Mechanical Dimensions	5
2. Hardware Interfaces	6
2.1 Appearance	6
2.2 Power Interfaces	7
2.3 Ethernet Interface	7
2.4 Device Restart and Default Restoration	7
2.5 Terminal Resistance DIP Switch	8
2.6 CAN Communication Interface	9
2.7 Signal Indicators	10
3. Hardware Connection	11
4. Working Modes	12
4.1 TCP Server Mode	12
4.2 TCP Client Mode	13
4.3 UDP Mode	14
5. Quick Instructions	15
5.1 Default Settings of the Device IP Address	15
5.2 Obtaining the Device IP Address	15
5.3 PC and Device Network Segment Detection	17
5.3.1 Windows98/ME Network Settings	17
5.3.2 Windows 2000/XP Network Settings	19
5.4 CANET-8E-U and USBCAN Interface Card Communication	22
6. ZNetCom Software Configuration	27
6.1 Installing Configuration Software	27
6.2 Obtaining Device Configurations	28
6.3 Modifying Device Configurations	31
6.4 Configuration Parameters	31
6.5 Saving Restored Settings	38
6.5.1 Saving Settings	38
6.5.2 Restoring Settings	38
6.6 Upgrading Firmware	39

7. Providing the Secondary Development Guidance for the Host Computer .	42
7.1 Preliminary Preparation for CAN Card Interface Function Development	42
7.2 Interface Library Function Usage Process	44
8. Appendix	45
8.1 CANET-8E-U Working Port Data Conversion Format	45
8.2 CANET-8E-U Data Conversion Format of TCP Notification Port in CAN Port State	47
9. Disclaimer	48

1. Functions

1.1 Overview

The CANET-8E-U is a high-performance industrial-grade Ethernet CAN-bus data conversion device developed by Guangzhou ZLG Electronics Co., Ltd. It integrates eight CAN-bus interfaces, one Ethernet interface and TCP/IP protocol stack, which allows you to easily interconnect CAN-bus network and Ethernet, and further expand the scope of CAN-bus network.

The CANET-8E-U is an industrial grade product and works in the temperature range of -40°C to $+85^{\circ}\text{C}$. It has 100M/1000M adaptive Ethernet interface. The highest baud rate of CAN port communication is 1 Mbps. It has various working modes such as TCP Server, TCP Client, and UDP. Each CAN port supports multiple TCP or UDP connections. You can flexibly set configuration parameters by using the configuration software. The following figure shows a typical application.

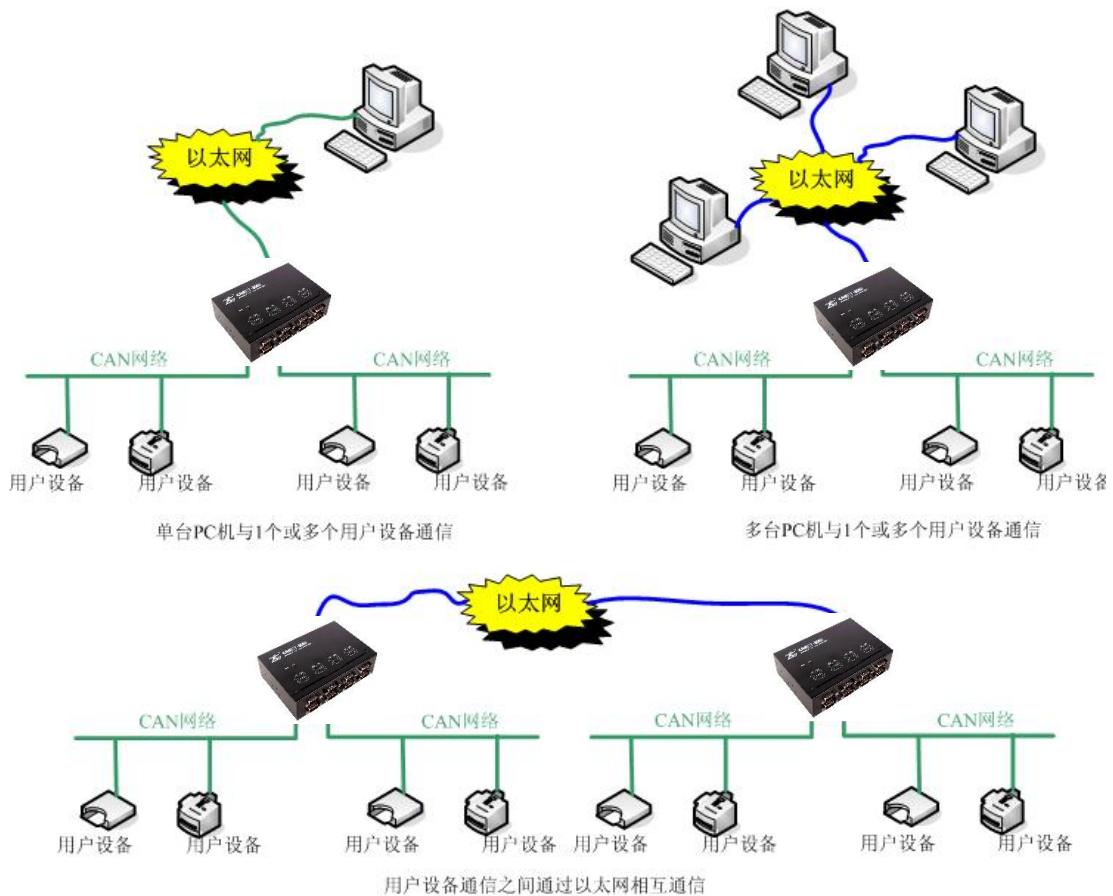

Figure 1.1 CANET typical application

1.2 Features

1.2.1 Powerful Hardware

- High-speed 800 MHz main-frequency 32-bit processor;
- 100M/1000M self-applicable Ethernet interface, 2 kV electromagnetic isolation;
- Eight CAN ports, 2.5 kVDC withstand voltage isolation;
- CAN port baud rate 5k-1,000kbps can be set arbitrarily;
- Embedded hardware watchdog timer;
- Power supply voltage range 9-48 V DC;
- Operating temperature: -40°C to +85°C;
- Humidity: 5%-95% RH, no condensation;
- Rugged metal housing, SECC metal (1.1 mm);
- Designed specifically for industrial environments.

1.2.2 Perfect Functions

- Static or dynamic IP acquisition;
- Heartbeat and timeout disconnection;
- The working port is fixed, and the destination IP address and port can be set;
- After the network is disconnected, the connection resources are automatically restored, and the TCP connection is established reliably;
- Manage one CAN port while satisfying six groups of users;
- In UDP mode, each CAN port supports six groups of target IP segments. Multiple users can manage a CAN device at the same time;
- Supported protocols include ETHERNET, ARP, IP, ICMP, UDP, DHCP, DNS, and TCP;
- Compatible with SOCKET working methods (TCP Server, TCP Client, UDP). The writing of the host computer communication software follows the standard SOCKET rules;
- Two-way transparent transmission of CAN data and Ethernet data (For the format, see Appendix 8.1);
- Flexible CAN port data framing settings meet various subcontracting needs;
- Each CAN port can be configured into different working modes, which can be flexibly used in various fields;
- Each CAN port opens a diagnostic port, and the host computer can obtain the error status of the corresponding CAN port by connecting this port;
- The operating parameters can be configured using the Windows configuration software;
- Provide Windows platform configuration software function library for free, including easy-to-use API function library, which helps users write their own configuration software;
- Support local system firmware upgrade.

1.3 Specifications

1.3.1 LAN

100M/1000M Ethernet, RJ45 interface, 2 kV electromagnetic isolation.

1.3.2 CAN

- Number of CAN ports: 8
- Interface type: DB9 (male)
- Signal cable: CAN0H-CAN0L, CAN7H-CAN7L
- Baud rate: 5 k-1,000 kbps

1.3.3 Software Features

- Supported TCP/IP protocols: ETHERNET, ARP, IP, ICMP, UDP, TCP, DHCP, DNS
- Communication software: CANtest test tool (V2.61), TCP/UDP test tool
- Configuration software: ZNetCom (V3.33 or later)

1.3.4 EMC Characteristics

Interface	Test Item	Testing Standards	Test Voltage	Test Result	Remarks
Power interface	Electrostatic test	IEC61000-4-2	±6kV	A	Contact discharge
			±8kV		Air discharge
	Group pulse test	IEC61000-4-4	±2kV	A	Capacitive coupling
	Surge test	IEC61000-4-5	±1kV	A	Differential mode
±2kV			A	Common mode	
Ethernet interface	Electrostatic test	IEC61000-4-2	±6kV	A	Contact discharge
			±8kV		Air discharge
CAN interface	Electrostatic test	IEC61000-4-2	±6kV	A	Contact discharge
			±8kV		Air discharge
	Group pulse test	IEC61000-4-4	±2kV	A	Capacitive coupling clip
	Surge test	IEC61000-4-5	±2kV	A	Common mode
Buttons, indicators	Electrostatic test	IEC61000-4-2	±8kV	A	Air discharge

1.3.5 Electrical Parameters

Unless otherwise specified, the parameters listed in the following table refer to the value at Tamb=25°C.

Parameter Name	Symbol	Rating	Unit
Power voltage	V _{CC}	+12	V
Power consumption	P _M	4000	mW
Operating ambient temperature	Tamb	-40°C~85°C	°C

CANET-8E-U

Storage temperature	Tstg	-40°C~85°C	°C
---------------------	------	------------	----

1.4 Mechanical Dimensions

To install CANET-8E-U, refer to the appearance and mechanical dimensions (unit: mm) provided in Figure 1.2. The figure specifies the length, width, height, and part of the mechanical structure of the product.

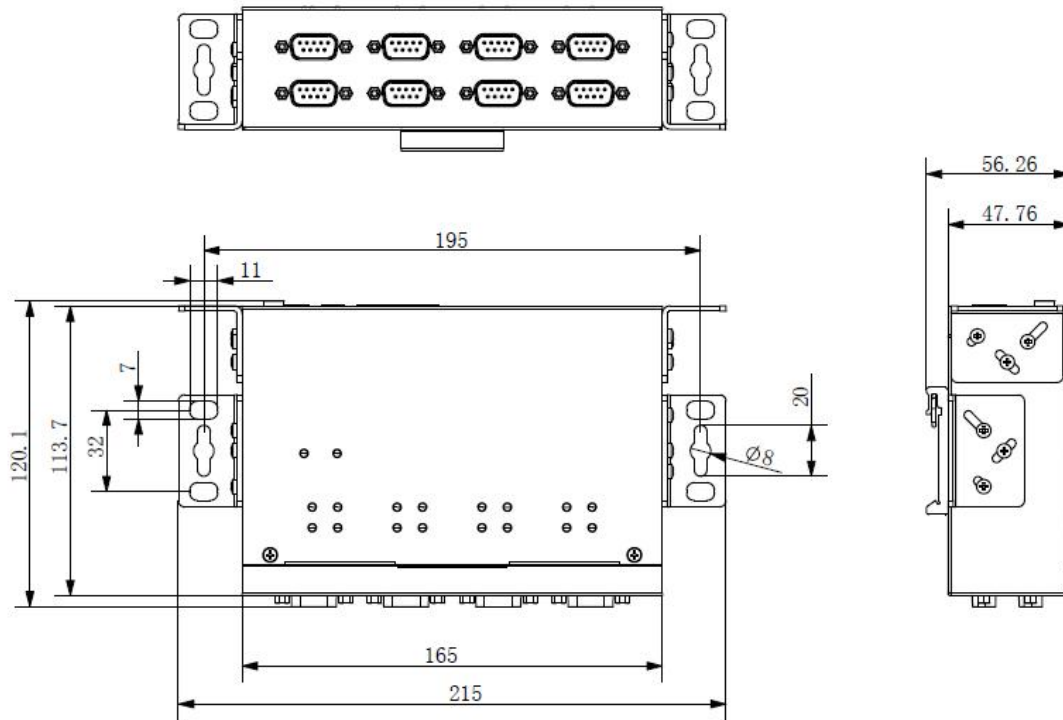

Figure 1.2 CANET-8E-U installation dimensions

2. Hardware Interfaces

This chapter describes the hardware interfaces of CANET-8E-U.

2.1 Appearance

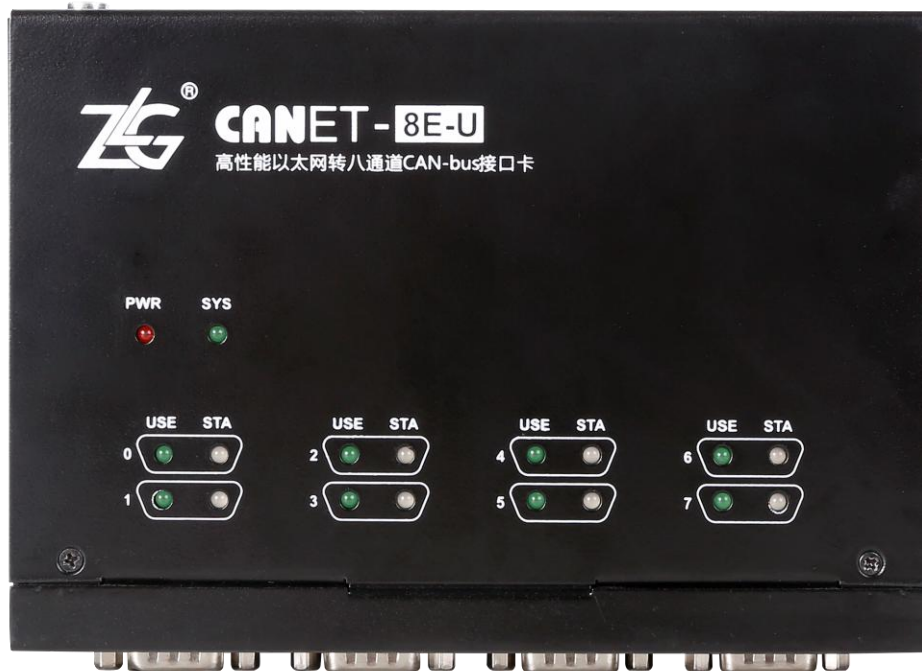

Figure 2.1 CANET-8E-U appearance

2.2 Power Interfaces

CANET-8E-U uses 9-48 V DC power supply. Two power input terminals are provided:

- 3Pin plug-in terminal;
- DC JACK socket (inside positive, outside negative).

Note: The power cable can be connected to either terminal, but not both power terminals at the same time.

The plug-in terminals are M3.5 terminal screws. Use crimp terminals for wiring. VIN is connected to the positive pole of the power supply, and GND is connected to the negative pole of the power supply. If the power is fully connected, the "PWR" indicator will remain red. The power port of CANET-8E-U also has a ground terminal, which is used to connect to the ground for static electricity or surge discharge.



Figure 2.2 Power interface signals

2.3 Ethernet Interface

CANET-8E-U has two Ethernet (RJ45) ports, as shown in Figure 2.3. Table 2.1 lists the definition of each pin.

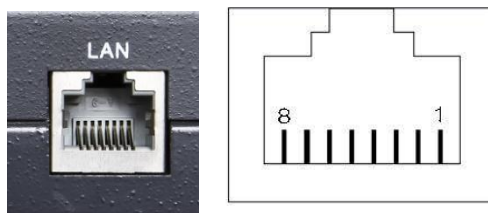

Figure 2.3 Appearance of RJ45 interface

Table 2.1 RJ45 pin definition

Pin	100M signal	1000M signal
1	TX+	DA+
2	Tx-	DA-
3	Rx+	DB+
4	-	DC+
5	-	DC-
6	Rx-	DB-
7	-	DD+
8	-	DD-

2.4 Device Restart and Default Restoration

Short-press RST (less than 2s). CANET-8E-U enters the restart state.

Long-press RST (longer than 5s). CANET-8E-U restores factory settings.

2.5 Terminal Resistance DIP Switch



To enhance the reliability of CAN communication, the two endpoints of the CAN bus network usually need to be equipped with terminal matching resistors. The value of the terminal resistor is determined by the characteristic impedance of the transmission cable. For example, if the characteristic impedance of the twisted pair is 120 ohm, the two endpoints on the bus should also integrate 120-ohm termination resistors. The CANET-8E-U interface card adopts CTM8251KT transceiver. If other nodes on the network use different transceivers, the terminal resistance must be calculated separately.

The function of the CAN bus terminal resistor:

- Improve the anti-interference ability to ensure that the bus quickly enters the recessive state;
- Improve signal quality.

CANET-8E-U uses a mechanical switch to select a terminal resistor. The DIP switch is at the bottom of the device, as shown in Table 2.2. The device's DIP switch is "ON" by default; that is, the default access terminal resistance is 120 ohm.

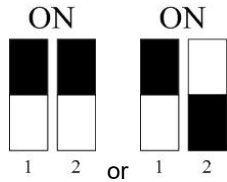
Table 2.2 CANET-8E-U terminal resistance DIP switch

Description	DIP switch
The corresponding CAN channel connects to 120 ohm	
The corresponding CAN channel has no access resistance	

2.6 CAN Communication Interface

The commonly used electrical connectors for CAN-bus communication interface are: DB9 socket, OPEN5 socket, OPEN3 socket, etc. The CANET-8E-U interface card integrates 1 to 8 CAN channels, which can be used to connect CAN-bus network or devices equipped with CAN-bus interface. The CAN-bus channel of CANET-8E-U adopts the standard male DB9 socket. Table 2.3 lists the DB9 pin definitions.

Table 2.3 DB9 pin socket pin signal definitions of CANET-8E-U

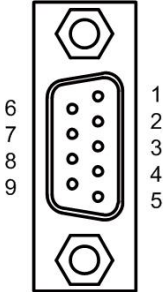
Pin	Signal	Description	Function
1	NC	Unused	
2	CAN_L	CAN_L signal cable	
3	CGND	Reference ground	
4	NC	Unused	
5	CAN_SHIELD	Shielded cable	
6	CGND	Reference ground	
7	CAN_H	CAN_H signal cable	
8	NC	Unused	
9	NC	Unused	

In some applications, some CAN-bus interfaces are OPEN-5 interfaces, and CANET-8E-U comes standard with eight DB9-to-OPEN5 connectors. Table 2.4 describes the signal definitions for the OPEN5 socket.

Table 2.4 Definition of accessories DB9 to OPEN5 signal

Pin	Signal	Description	Picture
1	V-	Reference	 <p>DeviceNet Color-code</p> <ul style="list-style-type: none"> Red White Bare Blue Black
2	CAN_L	CAN_L signal	
3	CAN_SHIELD	Shielded cable	
4	CAN_H	CAN_H signal	
5	V+	Unused	

2.7 Signal Indicators

The CANET-8E-U interface card has a power indicator PWR and a SYS indicator. Each corresponding channel has two CAN interface status indicators to indicate the operating status of the channel. Table 2.5 describes the indicators.

Table 2.5 Indicators of the CANET-8E-U interface card

Indicator	Status	Description
PWR	Red	Device powered on
SYS	Off	CANET device initialization has not completed
	Green flashing	The CANET device is initialized and is running properly
USE	Green on	No meaning
STA	Off	The corresponding channel has no message transmission
	Green flashing	The corresponding channel is transmitting packets
	Red flashing	Bus error

3. Hardware Connection

In general, the CANET-8E-U can be used to bridge CAN_Bus and Ethernet, which interconnects your CAN_Bus and Ethernet and allows PCs to control the devices on the your CAN_Bus network through the Ethernet. Figure 3.1 shows a typical application.

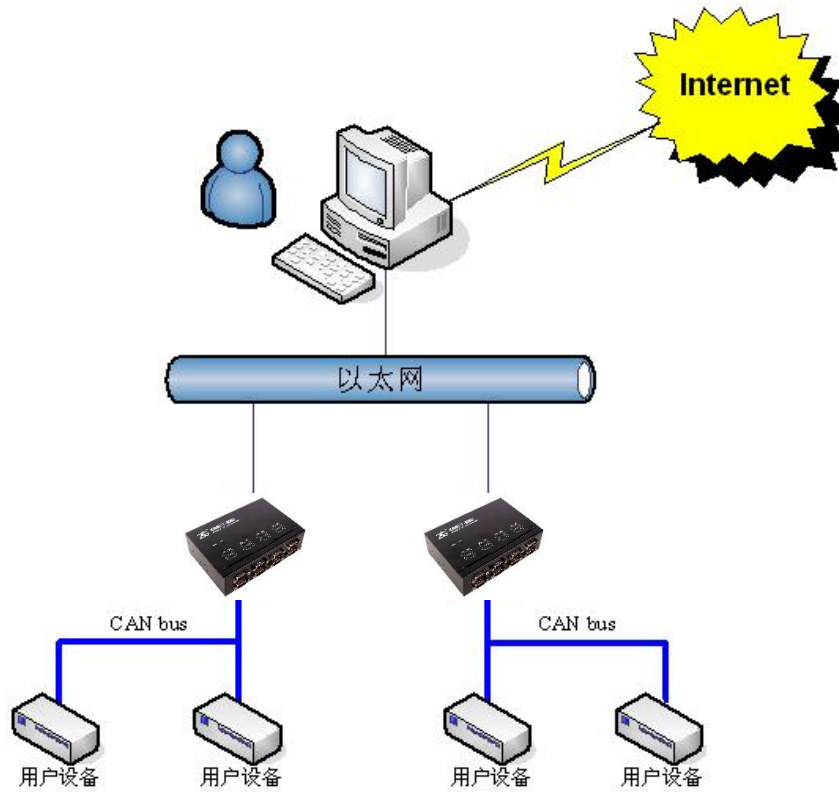

Figure 3.1 Typical application of the CANET device

Simple tests can be performed using the CANTest software.

4. Working Modes

The CANET-8E-U has three working modes, which are described as follows:

4.1 TCP Server Mode

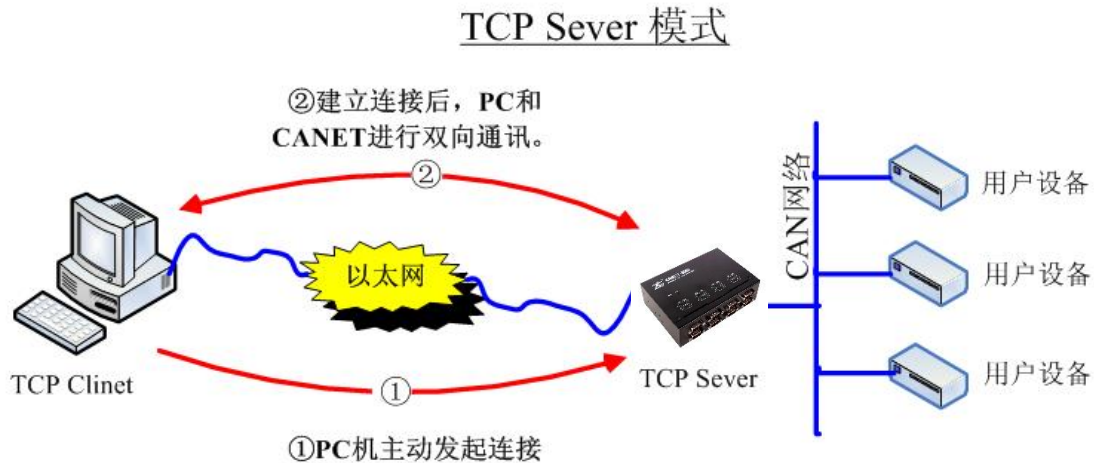

Figure 4.1 TCP Sever mode communication

In TCP Server mode, CANET-8E-U will not actively connect to other devices. It always waits for the connection of the client (TCP Client), and can perform two-way data communication after establishing a TCP connection with the client. Figure 4.1 shows the communication establishment process.

Tip: In this mode, the client connects to the CANET-8E-U device over the "working port (see Table 6.1)" corresponding to the CAN port.

4.2 TCP Client Mode

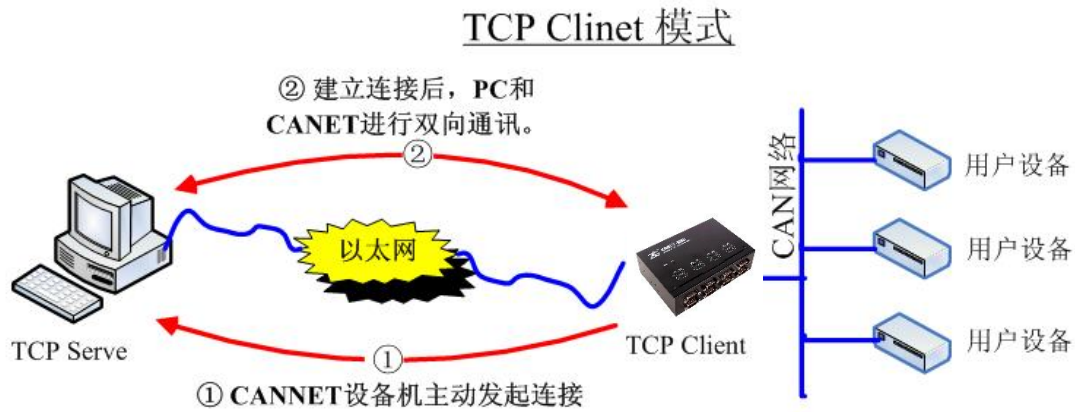

Figure 4.2 TCP Client mode communication

In TCP Client mode, the CANET-8E-U will actively connect to the preset TCP server. If the connection fails, the client continuously tries to establish a connection with the TCP server based on the preset connection conditions. After establishing a TCP connection with the TCP server, two-way data communication can be carried out. 图 4.2 shows the communication establishment process.

Tip: In this mode, the TCP server IP address is determined by "destination IP (see Table 6.1)"; the TCP server port is determined by "destination port (see Table 6.1)". There are six groups of valid "Destination Port" and "Destination IP". The device will connect to the TCP server specified by the six groups of parameters in turn based on the preset number of connections until the connection is successful.

4.3 UDP Mode

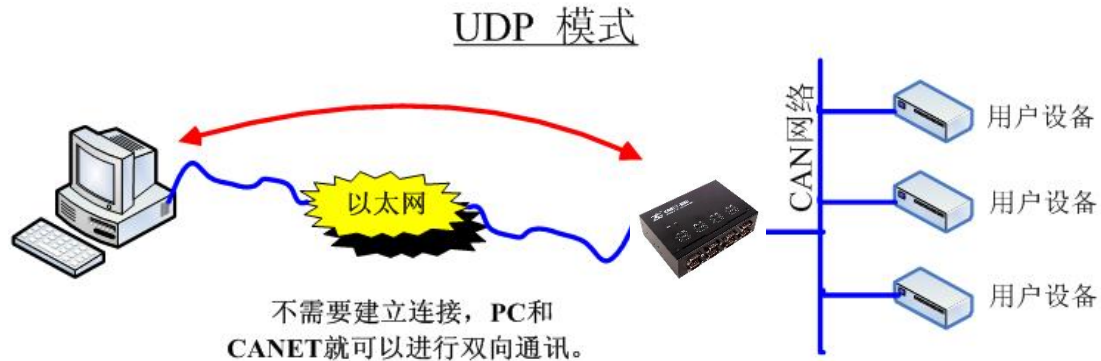

Figure 4.3 UDP mode communication

In UDP mode, the UDP protocol is used for data communication. UDP is a non-connection-based communication method. It cannot guarantee that the data packets sent to the target host will be received correctly. Therefore, in the scenarios with high reliability requirements, the upper-layer communication protocol must be used to ensure that the data is correct; however, because UDP is a simple communication method, it will not increase too much additional communication volume, and can provide a higher communication speed than the TCP method to ensure the real-time transmission of data packets. In fact, when the network environment is simple and the network communication load is not too large, the UDP working method is not error prone. The devices working in this mode are equal, and there is no server and client. Figure 4.3 shows the communication process.

Tip: In this mode, CANET-8E-U uses "working port (see Table 6.1)" to receive UDP packets sent by user equipment; the data received by the CAN port of the CANET-8E-U device will be sent to the "destination port (see Table 6.1)" of six groups of valid "destination IP (see Table 6.1)".

5. Quick Instructions

This chapter describes the basic usage of CANET-8E-U and the installation settings of related software and hardware.

Before using the CANET device, learn about the network parameters such as the IP address of the device. The CANET device supports two IP acquisition methods: "static acquisition" and "dynamic acquisition". "Static acquisition" indicates that the device uses the "IP address", "subnet mask" and "gateway" specified by the user; "Dynamic acquisition" indicates that the device obtains the IP address, subnet mask, and gateway information from the DHCP server on the network over DHCP.

 Tip: If the IP acquisition method is "dynamic acquisition", CANET-8E-U cannot be directly connected to the computer and needs to use a router. In addition, the DHCP function must be enabled on the router; otherwise, the CANET-8E-U cannot be assigned with an IP address.

5.1 Default Settings of the Device IP Address

The default IP address of CANET-8E-U is 192.168.0.178.

5.2 Obtaining the Device IP Address

When you forget the IP address of the device or the device uses the DHCP protocol to obtain the IP address automatically, you can obtain the current IP address of the device by using the ZNetCom software (version 3.33 or later).

The ZNetCom software is the configuration software of CANET equipment running on Windows platform. No matter what the current IP address of the CANET device is, you can obtain the current IP address of the CANET device by using the ZNetCom software, and configure it. To obtain the CANET device IP using ZnetCom software, proceed as follows:

Connect the device to a 9-48 V DC power supply. Use a crossover cable to connect the device's LAN port to the PC's network port.

Install ZNetCom software (version 3.33 or later), which can be downloaded from www.zlg.cn.



Double-click  to run the ZNetCom software (if the system is later than Windows 7, right-click it and run as administrator). The interface shown in Figure 5.1 appears.

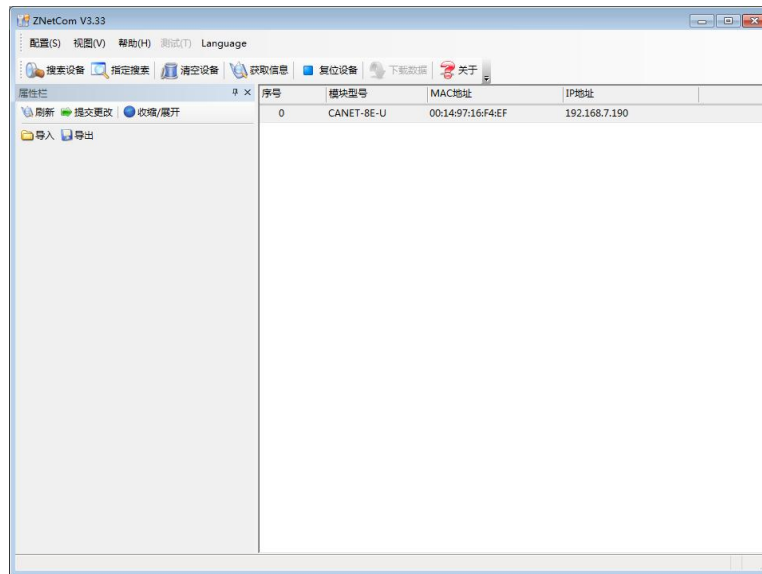



Figure 5.1 ZNetCom software running interface

Click . The interface shown in Figure 5.2 appears, and you can learn the IP address of the device.

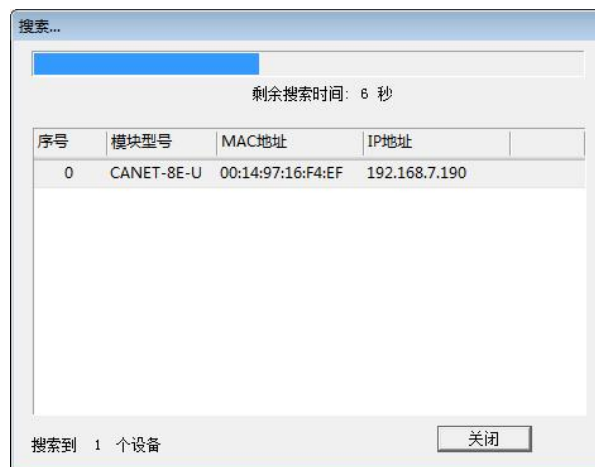

Figure 5.2 Searching a device by using the ZNetCom software

5.3 PC and Device Network Segment Detection

Before using the PC to communicate with the CANET device, ensure that there is an Ethernet card in the PC, and the PC and the CANET device must be on the same network segment.

The CANET device is set with a default IP address (192.168.0.178) and network mask (255.255.255.0) when it leaves the factory. Check whether the device is on the same network segment as the user's PC according to the process shown in Figure 5.3. If you are on the same network segment, you do not need to read the following content about the PC network settings. If different, the following PC network settings are very important for you.

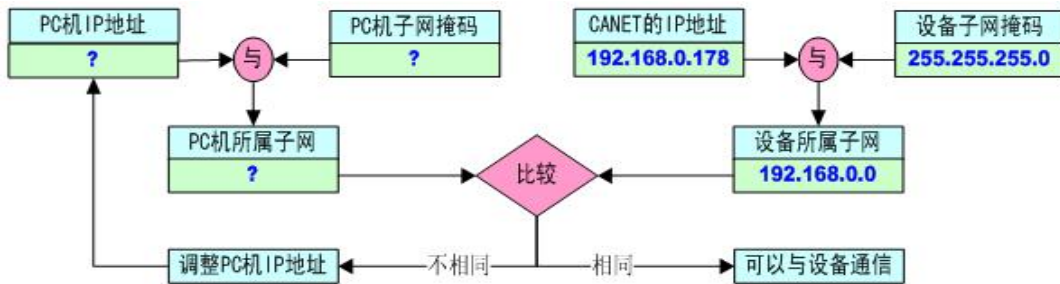

Figure 5.3 Checking whether the IP address of the CANET device and the PC are on the same network segment

The following describes how to make the user's PC and CANET equipment be on the same network segment.

5.3.1 Windows98/ME Network Settings

If you use Windows 98/ME, enter the operating system, click the "Start" → "Settings" → "Control Panel" on the taskbar, and double-click the "Network" icon. The interface shown in Figure 5.4 is displayed.



Figure 5.4 Opening Network Settings

Select the properties of "TCP/IP" on the "Configuration" page. Probably you will see more than one "TCP/IP". Select the "TCP/IP" property of the network card connecting the CANET device. The interface appears, as shown in Figure 5.5.

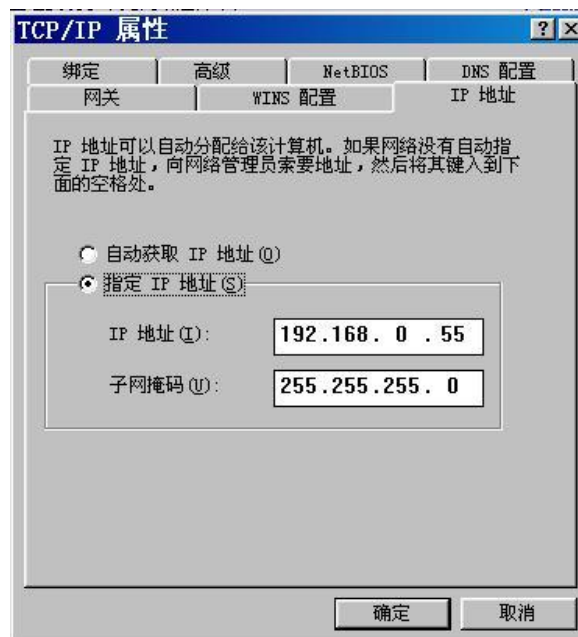

Figure 5.5 TCP/IP properties

Select "Specify IP Address" on the "IP Address" page, and enter the IP address 192.168.0.55 and the subnet mask 255.255.255.0. Click OK on this page, and restart the PC as prompted.

5.3.2 Windows 2000/XP Network Settings

If you are using Windows 2000/XP, there are two ways. One is to add the local IP address, and the other is to modify the local IP address.

1. Add a local IP address

It is assumed that the IP address of the user's PC is 192.168.2.3, and the IP address of the CANET device is the default IP address 192.168.0.178.

In the operating system, right-click My Network Neighborhood → . The Network Connections window is displayed. Select the local area connection icon (Note: The connection is a CANET device network connection. If the user has multiple network cards, there may be multiple local area connections), right-click the local area connection →. The window shown in Figure 5.6 appears.



Figure 5.6 Network properties

Select "Internet Protocol (TCP/IP)" under "This connection uses the following (D):" on the "General" page. Click Properties. The window shown in Figure 5.7 appears.

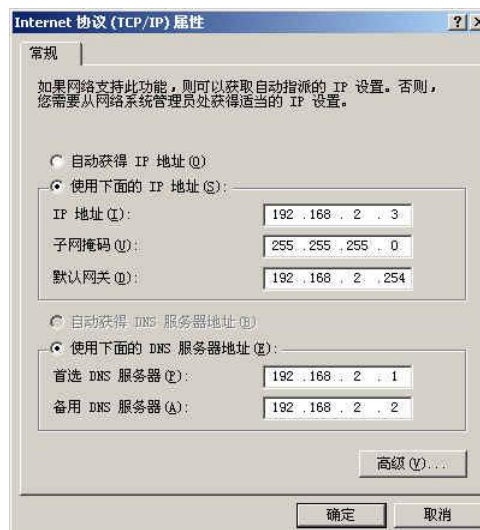

Figure 5.7 TCP/IP properties

Click the "Advanced (Y)..." button in the window. The window shown in Figure 5.8 appears.



Figure 5.8 TCP/IP settings

On the "IP Settings" page, click the Add button in the "IP Address (R)" column. The window shown in Figure 5.9 reappears.



Figure 5.9 Adding an IP address

Enter the content, and press the Add button. Press OK. Now you can communicate with the CANET device.

2. Modify the local IP address

In the operating system, click "Start", "Settings", "Control Panel" on the taskbar (or directly open "Control Panel" in "My Computer"), double-click "Network and Dial-up Connections" (or "Network Connections"). Select "Local Area Connection" corresponding to the network card connected to the CANET device, right-click and choose "Properties".

On the "General" page, select "Internet Protocol (TCP/IP)", view its "Properties". The page shown in Figure 5.10 appears. Select [Use the following IP address], and enter the IP address 192.168.0.55, the subnet mask 255.255.255.0, and the default gateway 192.168.0.1 (the DNS part can be left blank). Click "OK" on this page and "OK" on the "Local Area Connection Properties" page, and wait until the system is configured.

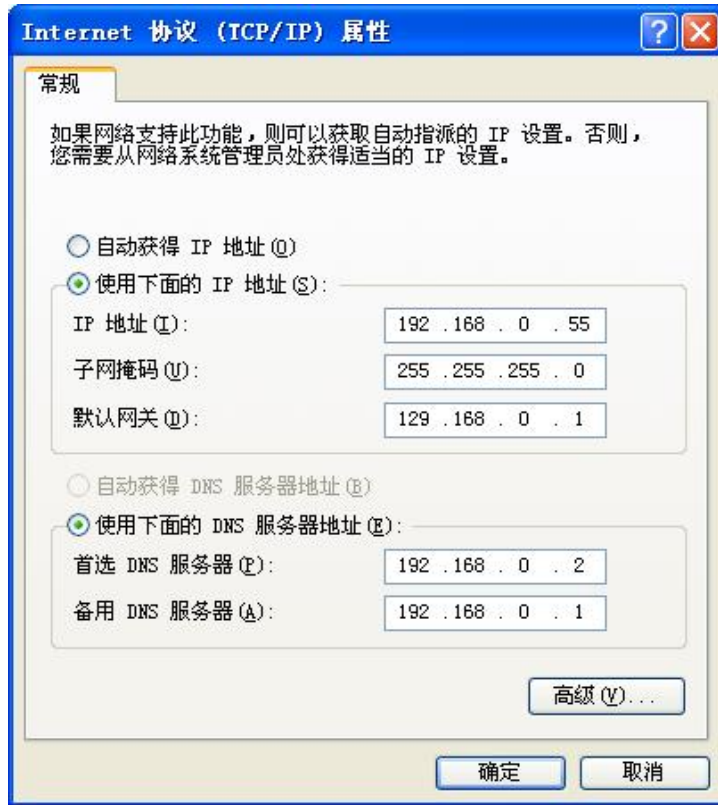

Figure 5.10 TCP/IP Properties window

5.4 CANET-8E-U and USBCAN Interface Card Communication

We need a device equipped with a CAN port to demonstrate how the CANET device realizes bidirectional transparent conversion of CAN network data and Ethernet data. Here, select the USBCAN-II interface card, which is convenient to use. Its related information is available at <http://www.zlg.cn>.

First, connect the CANET device to the PC by using a network cable, connect the CANET device to the USBCAN-II interface card by using a twisted pair (CANH is connected, CANL is connected), connect the USBCAN-II by using a USB cable, connect power to the device. Run the CANtest software on the PC (as shown in Figure 5.11). The CANtest test software can be downloaded from the delivered CD-ROM or the www.zlg.cn.



Figure 5.11 Software used to test communication

The following communication operations are based on the premise that the parameters have been configured for CANET-8E-U. The device IP address is changed to the IP address of the same network segment of the test computer, 192.168.7.190. The CAN0 port is configured as TCP Server, and the working port is 4001.

View the computer IP address, as shown in Figure 5.12. Make sure that CANET (192.168.7.190) and the test computer (192.168.7.89) are on the same network segment.

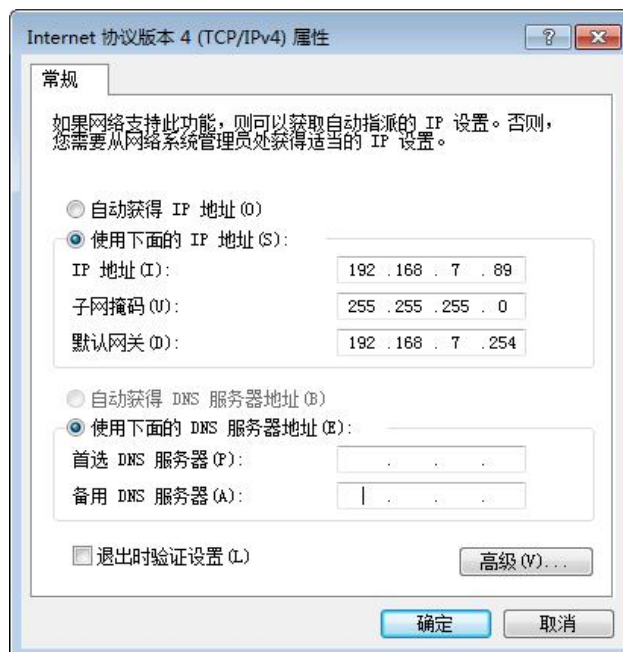

Figure 5.12 Viewing the IP address of the test computer

After starting CANtest, select the device type. Select CANET-TCP, as shown in Figure 5.13, and select the "Open Device" menu in the "Device Operation" main menu. The related parameter setting interface of the device appears. The IP address of the device has been changed to 192.168.7.190 using the ZNETCOM software, and the working port is 4001. Therefore, enter 192.168.7.190 and 4001 in the IP address and port number of the device, as shown in Figure 5.14.

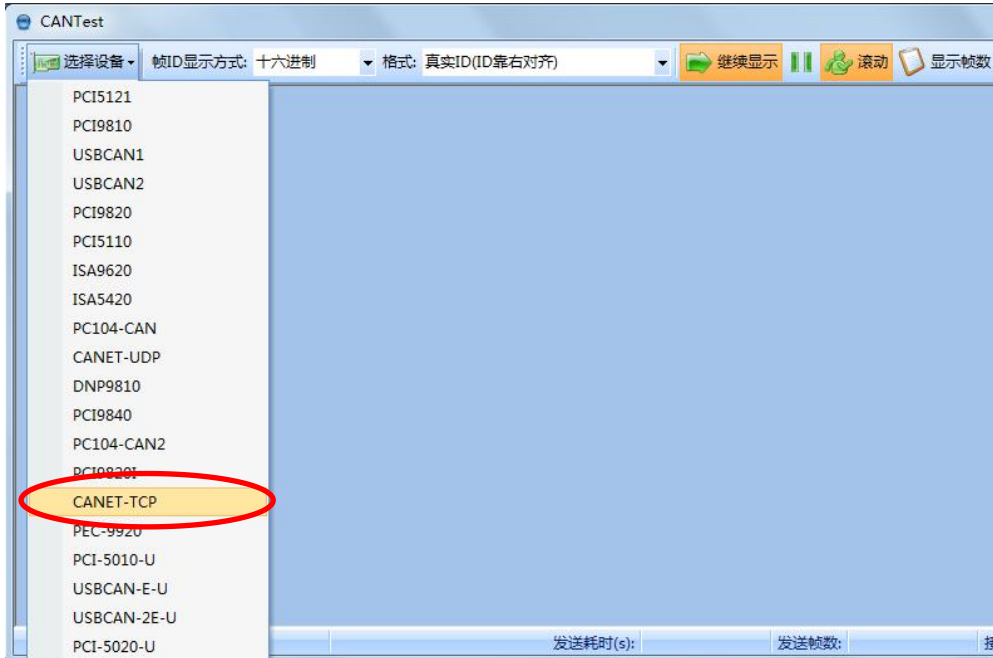

Figure 5.13 Selecting a device type



Figure 5.14 Setting device parameters

Click the "OK and start CAN" button or click "OK". Click "Start" on the data operation interface (as shown in Figure 5.15). If the device is connected properly, no message appears; if the connection is abnormal, an error message appears.

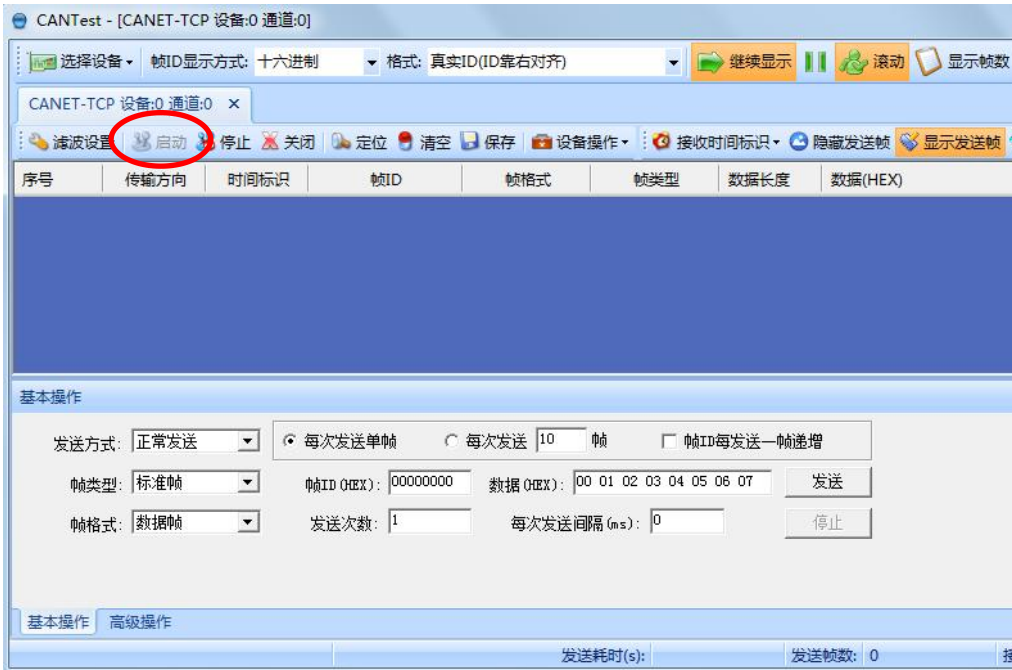

Figure 5.15 Starting CANET-8E-U

Click the CANtest software again to select a device. This time we choose USBCAN2, as shown in Figure 5.16. Select the "Open Device" menu in the "Device Operation" main menu. The parameter setting interface appears, as shown in Figure 5.17.

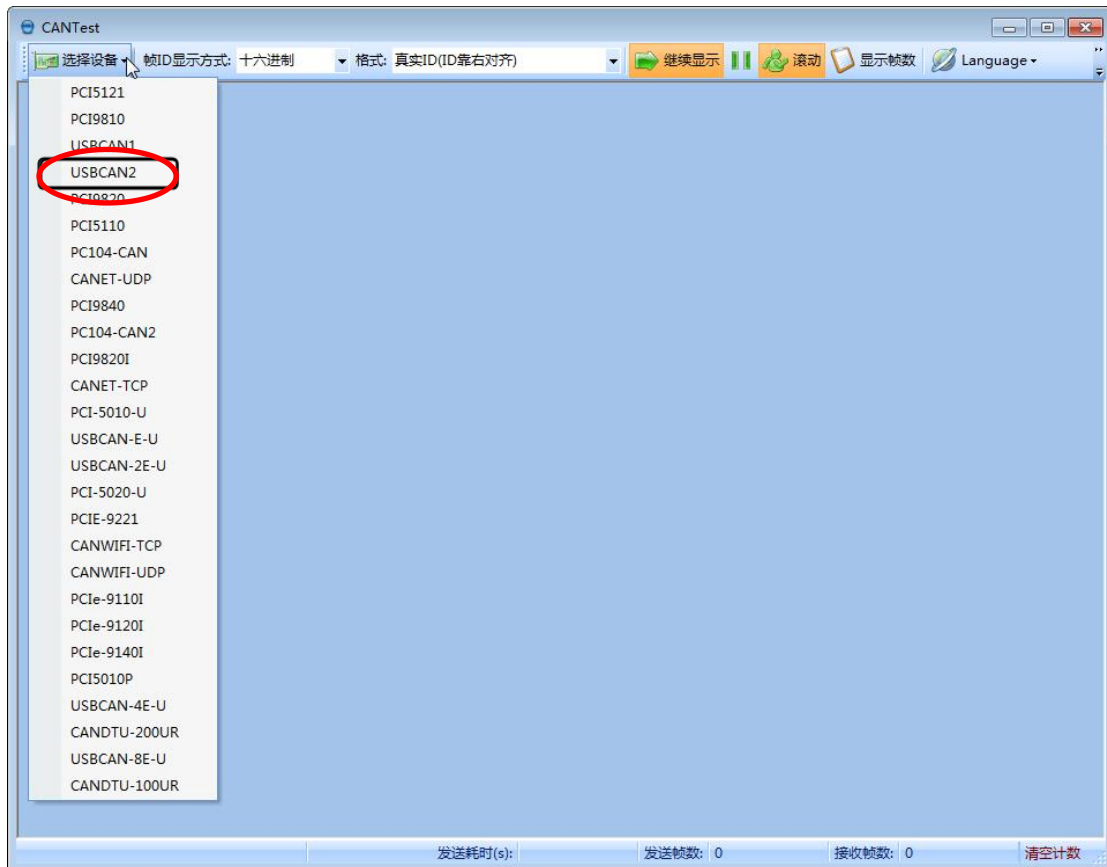

Figure 5.16 Selecting a device type



Figure 5.17 Parameter settings

Because the default baud rate of the CAN port is 1,000 kbps, select 1,000 kbps in the baud rate, and retain default values for other parameters. After you click "OK", the main interface is displayed. On the main interface, click the "Start CAN" button (as shown in Figure 5.18) to start the corresponding CAN port. All preparations are made. Next, you can realize the communication between CANET and USBCAN-II.



Figure 5.18 Starting the USBCAN card

On the tab interface of any CANtest software, click the "Send" button. You can receive the data you just sent on another CANtest software tab page, as shown in Figure 5.19.



Figure 5.19 Demonstrating two-way communication

After you have an intuitive understanding of the CANET device, you can continue to understand the following content, which will help you master how to configure the CANET device as your CANET device.

6. ZNetCom Software Configuration

The ZNetCom software is dedicated configuration software for CANET equipment running on Windows. You can obtain the IP address of the CANET device, view and change the device configuration parameters, and upgrade the device firmware by using the ZNetCom software.

6.1 Installing Configuration Software

Search for "ZNetCom" at the ZLG Electronics official website www.zlg.cn to download the latest version.

Double-click the unzipped EXE file. The welcome window shown in Figure 6.1 appears. Click [Next].

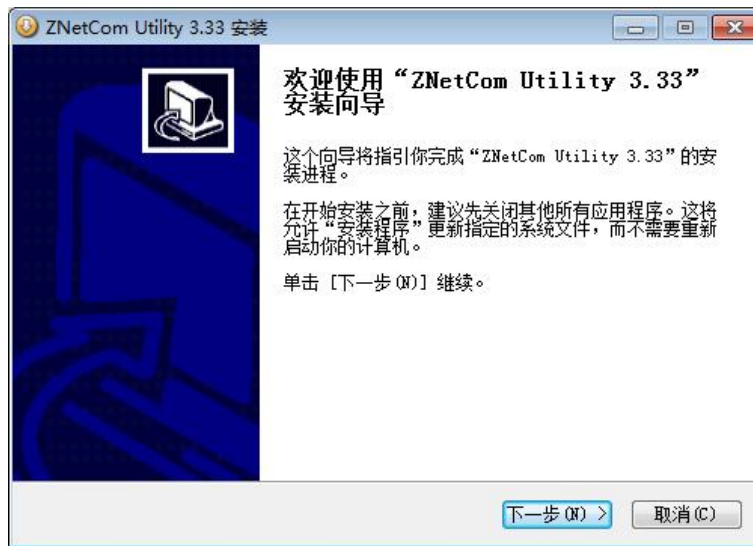

Figure 6.1 Welcome interface

The window shown in Figure 6.2 is displayed, asking for the installation path (the default path is C:\Program Files\ZNetCom Utility). To change the installation path, click the [Browse] button.

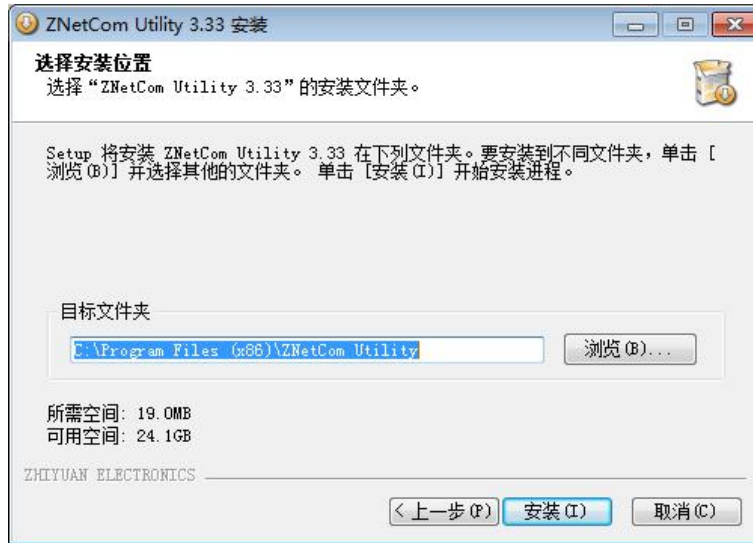

Figure 6.2 Selecting an installation path

Click [Install] to copy the files to the installation path. After the installation is complete, the prompt window for successful installation as shown in Figure 6.3 appears. Click [Finish] to exit the installation software.



Figure 6.3 Installation complete

The configuration software is installed. Check whether the CANET device and the PC network card have been connected over the matching network cable.

6.2 Obtaining Device Configurations

Run the ZNetCom software. The interface shown in Figure 6.4 appears.

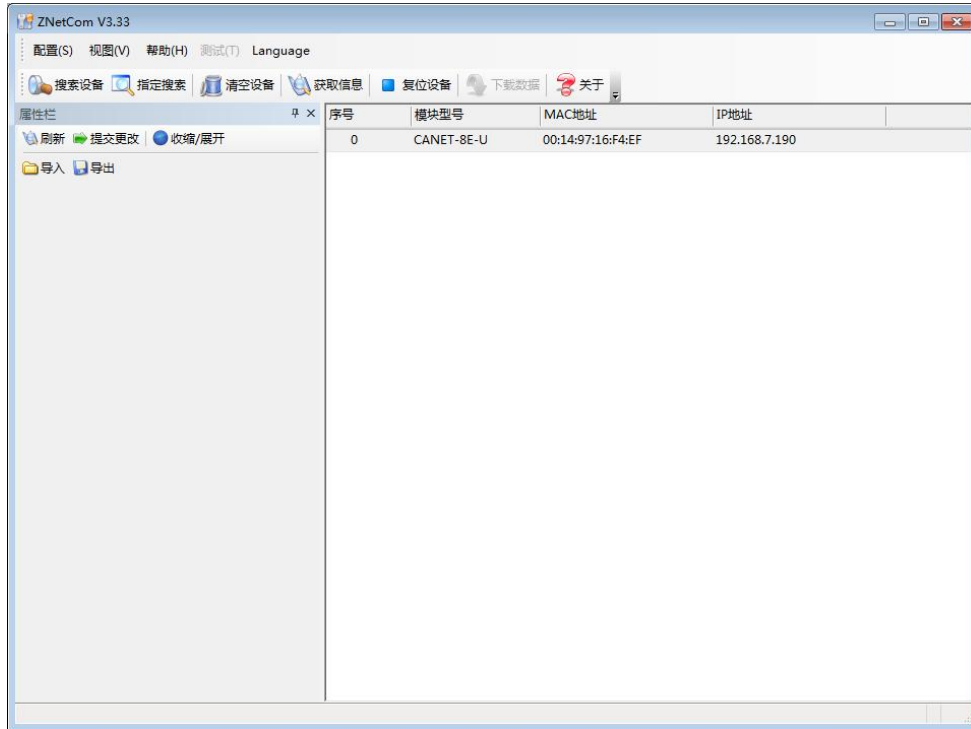
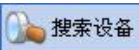

Figure 6.4 ZNetCom running interface

Click  in the toolbar. The ZNetCom configuration software starts to search for CANET devices connected to the PC, as shown in Figure 6.5. In the search window, we can see the searched device, and the corresponding MAC address and IP address. The search window closes automatically after 10 seconds. You can also click the [Stop] button to close it.

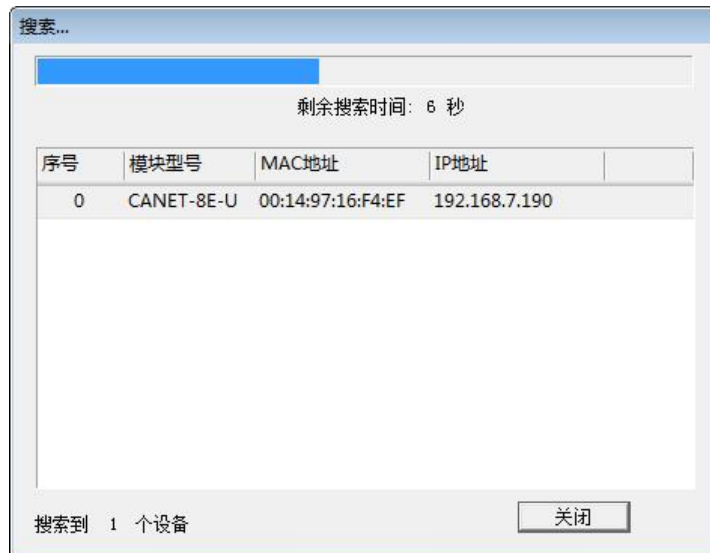

Figure 6.5 Searching the device by using the ZNetCom software

After the search is completed, the searched devices appear in the device list of the ZNetCom software, as shown in Figure 6.6.

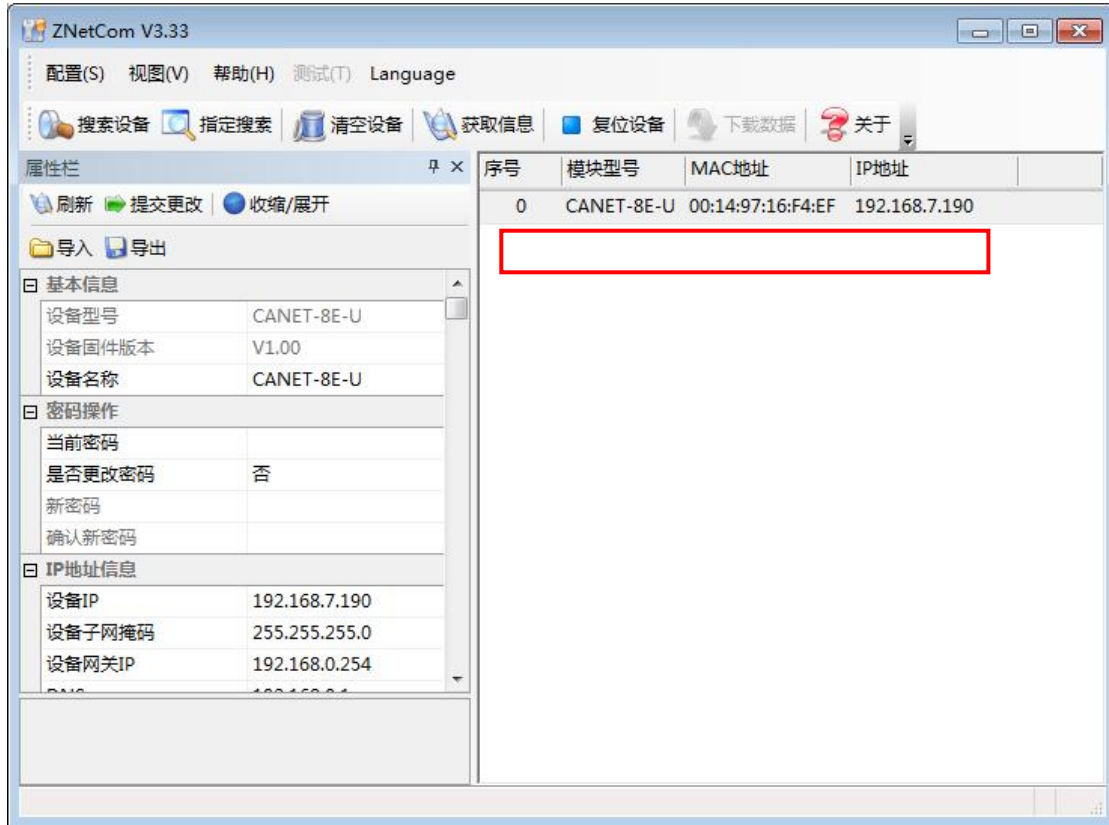

Figure 6.6 Obtaining CANET device configuration properties



Double-click the device item in the device list; or after selecting the device item, click  in the toolbar or  in the property bar. The "Get Device Information" dialog box appears, as shown in Figure 6.7.



Figure 6.7 Getting configuration data

When the "Get Device Information" dialog box disappears, you can see the CANET device configurations as shown in Figure 6.8 from the property column.

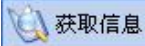
基本信息	
设备型号	CANET-8E-U
设备固件版本	V1.00
设备名称	CANET-8E-U
密码操作	
当前密码	
是否更改密码	否
新密码	
确认新密码	
IP地址信息	
设备IP	192.168.7.190
设备子网掩码	255.255.255.0
设备网关IP	192.168.0.254
DNS	192.168.0.1
设备MAC地址	00:14:97:16:F4:EF
获取IP方式	静态获取
网页端口	0
命令端口	0
CAN0配置	
设置所有CAN0配置和此CAN0口相同	
TCP工作方式	TCP SERVER
是否固定端口	不固定
工作端口（连接端口）	4001
TCP通知端口	6001
超时断开时间(10ms)	0
心跳时间(10ms)	200
CAN波特率(HEX)	1000K
工作模式	正常
分包帧数	50
分包时间间隔	1
清空CANBuffer	TCP连接时清空
CAN_AF	禁用
滤波验收码	00
滤波屏蔽码	FFFFFFFF
CAN最小发送间隔	0

Figure 6.8 CANET device configurations

6.3 Modifying Device Configurations

When you modify the CANET device configurations by using the ZNetCom software, the device configuration password (the default value is "88888") is required to submit the change successfully. After you modify the device configurations in the property column,

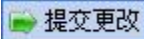
enter the device configuration password in the current password, click  to complete the device configuration modification.

6.4 Configuring Parameters

Table 6.1 describes the default settings for the CANET-8E-U device.

Table 6.1 "Property Column" description

Category	Name	Default	Description
Basic information	Device type	CANET-8E-U	This item cannot be changed.
	Device firmware version	It is related to the device delivery time.	Display the latest firmware version number of the device.
	Equipment name	CANET-8E-U	The value can be changed and contains a maximum of nine characters, consisting of a to z, A to Z, 0 to 9. Modifying this value is useful for users to identify multiple CANET-8E-U devices on the same network.
Password operation	Current password	"88888"	Before changing other items, you must enter the correct password. The password contains a maximum of 9 characters, including a to z, A to Z, 0 to 9.
	Whether to change the password	No	You can set "New Password" and "Confirm Password" only if you select "Yes".
Password operation	New password	None	If "Whether to change the password" is "No", the password cannot be changed. Used to enter a new password. The password contains a maximum of 9 characters. For the character range, see the description in the "Current Password" column.
	Confirm the new password	None	If "Whether to change the password" is "No", the password cannot be changed. Used to confirm the new password. It must be the same as "New Password".
IP address information	Device IP address	192.168.0.178	X.X.X.0 or X.X.X.255 cannot be filled. An IP address is an address on a network assigned by a network device (such as a PC and CANET-8E-U). It is unique on the same network.
	Device subnet mask	255.255.255.0	The subnet mask is very important to the network. Within the same network, the IP address and subnet mask are the same value. So set the "IP address" and "Subnet mask" correctly.
	Device Gateway IP address	192.168.0.1	Enter the IP address of the gateway within the network or the IP address of the router.
	Device MAC address	The value is different for each module	This item cannot be changed.

Continued

Category	Name	Default	Description
IP address information	How to get an IP address	Static acquisition (Static)	You can also select "Dynamic acquisition". Static acquisition means that the user directly enters the "IP address", "Subnet mask", and "Gateway". Dynamic acquisition means that the CANENT-8E-U module uses the DHCP protocol to obtain the IP address, subnet mask and gateway information allocated by the DHCP server on the network. Note: The function of dynamic acquisition can only be used when there is a DHCP server on the network. Usually, the router can also serve as a DHCP server.
CAN port configurations	Heartbeat time (10 ms)	200	The values that can be filled are 0 and 100-65525. This item is meaningful only when the TCP protocol is used for communication. When the TCP connection is established, a "heartbeat packet" (non-application data will not be forwarded to the working port) will be sent every time interval filled in this item. The CANET-8E-U will disconnect the connection if the other party does not respond to three consecutive heartbeat packets. If you fill in "0", the "heartbeat packet" will not be sent.
	CAN baud rate (HEX)	1000K	There are 15 options from 5K to 1000K. You can also enter any baud rate value yourself.
	CAN working mode	Normal	Normal: The CAN port can respond to the received CAN frame properly; Listen only: The CAN port works in listening mode and does not respond; Self-test: The CAN port works in self-transmitting and self-receiving mode. This is used to check whether it can properly and whether it is damaged.
	Packet frames	50	The value ranges from 1 to 50. When the CAN port continuously receives data (the interval is less than the sub-packet time interval), and the number of received CAN frames reaches the "number of sub-packet frames", the received data is encapsulated into an Ethernet packet and sent to the network port. Packet Frames refers to the maximum number of frames in a packet.If the number of packet frames is not reached during the receiving process, and the frame interval

			exceeds the packet time interval, the received data is also encapsulated into an Ethernet packet and sent. If the number of packetized frames is set to 1, it means no packetization. Each CAN frame is sent as a separate Ethernet packet, and the real-time performance is the best at this time, but the network load is the highest; If the number of sub-packet frames is set to 50, the channel traffic is the largest and the network load is the smallest.
	Packet time interval (ms)	1	The value ranges from 1 to 254. When the CAN port does not receive a new data frame within the time defined by the "packet time interval" (unit: ms), and the number of packet frames has not been reached, all data frames that have been received and have not been sent will be encapsulated into an Ethernet packet and sent to the network port.
	Clear CANBuffer	Never cleared	This option is only valid in TCP working mode. It determines whether to clear the data in the CAN port Buffer after the connection is established. If it is not empty, the data in the Buffer will be sent after the connection is established. If it is cleared when TCP connection is selected, the saved CAN buffer will be cleared when the TCP connection is established.

Continued

Category	Name	Default	Description
CAN port configurations	CAN_AF	Disabled	CAN interface acceptance filter enabling After enabling, enter the upper and lower limits of the standard frame ID and the upper and lower limits of the extended frame ID to be received in the following four items.
	Upper limit of the standard frame	7FF (HEX)	After CAN_AF is enabled, the upper and lower limits of the receiving standard frame ID set by the user together determine the range of the standard frame ID to be received.
	Lower limit of the standard frame	000 (HEX)	
	Upper limit of the extended frame	1FFFFFFF (HEX)	After CAN_AF is enabled, the upper and lower limit values of the received extended frame ID set by the user together determine the range of the extended frame ID to be received.
	Lower limit of the extended frame	00000000 (HEX)	
	CAN send buffer number (10 frames)	65535	CAN interface transmit buffer size. The default value is 65535x10 frames. You can set the buffer size to adjust the balance between the real-time performance of the CAN port and the large-capacity buffer. Because the speed of Ethernet is much higher than the transmission speed of CAN, the CAN needs to buffer transmission if the amount of data received by the Ethernet is too large. This ensures that no frames are dropped, but such a large buffer may lead to poor real-time performance. That is, the data currently sent by the Ethernet needs to wait for a certain period of time to be sent out from the CAN interface. In this case, either the client controls the transmission speed of the Ethernet to match the transmission speed of the CAN port; or the buffer is changed to a smaller size and the frame is dropped appropriately to ensure real-time performance.
	CAN transmit buffer policy	Discard new data when buffer is full	Policy when the CAN interface transmit buffer is full: Discard new data when the buffer is full and discard old data when the buffer is full

	Number of TCP connections (number of destination IP segments)	1	<p>When CANET-8E-U works in TCP Sever, each CAN port can have a maximum of 255 TCP connections by default without configuration;</p> <p>When working in TCP Client mode, this item is used to define the number of connection IP segments allowed to be established during communication with the corresponding CAN port. The maximum value is 6 segments.</p> <p>When working in UDP mode, this item is used to define the number of IP segments where the network device communicating with the corresponding CAN port is located. The maximum value is 6 segments.</p>
	Destination port 1	8001-8004	<p>Available values are 1 to 65535. Only valid in TCP Client and UDP working modes. Used to define the port of the network device that communicates with the CANET device. Only the network data sent through this port can be received by the CANET device, and the data frame received by the CAN port of the CANET device will also be sent to this port through Ethernet. The default CAN0 destination port 1 is 8001, CAN1 destination port is 8002, CAN2 destination port is 8003, and destination port CAN3 is 8004.</p>

Continued

Category	Name	Default	Description
CAN port configurations	Subnet mask 1	255.255.255.0	The subnet mask determines whether the host number of the network and whether the host number is legal, such as the network segment 192.168.1.x. If the subnet mask is 255.255.255.0, the IP 192.168.1.255 is a broadcast address and cannot be used to represent a host. But if the subnet mask is 255.255.0.0, 192.168.1.255 is an illegitimate device address
	Start address 1	192.168.0.55	Only valid in TCP Client and UDP working modes. It is used to define the destination IP address; that is, the port IP address of the network device that communicates with the CANET device (it can also be the starting IP address in the IP address segment), or it can be a domain name.
	End address 1	192.168.0.55	Only valid in TCP Client and UDP working modes. Used to define the end IP address in the IP address segment. If there is only one destination address, the end address can be the same as the start address. Note: If the IP address segment is filled in the end address, multiple network devices will communicate with CANET-8E-U at the same time. The first three bytes of the IP address segment must conform to the subnet mask 1 limit, and the fourth byte of the ending address must be greater than or equal to the fourth byte of the starting IP address.
	Destination ports 2-6	0	The value ranges from 1 to 65535. The function is the same as the destination port 1. To enable it, set the number of TCP connections.
	Subnet masks 2-6	0.0.0.0	Disabled by default. To enable it, set the number of TCP connections
	Start addresses 2-6	0.0.0.0	The function is the same as the starting address 1. To enable it, set the number of TCP connections
	End addresses 2-6	0.0.0.0	The function is the same as the starting address 1. To enable it, set the number of TCP connections

Continued

Except for the working port, destination port and destination IP address, the default parameter values of CAN0-CAN7 are exactly the same; the meaning of each parameter is the same as that of each parameter of CAN0.

6.5 Saving Restored Settings

To help users modify the configurations of CANET equipment in batches, the ZNetCom software provides the function of importing/exporting configurations. The Import/Export function button is located on the property column, as shown in Figure 6.9.



Figure 6.9 Device configurations import/export

6.5.1 Saving Settings

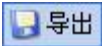
Click . In the "Save As" dialog box (as shown in Figure 6.10), select the save path, enter the file name, and click [Save]. Device configurations will be saved in XML format.

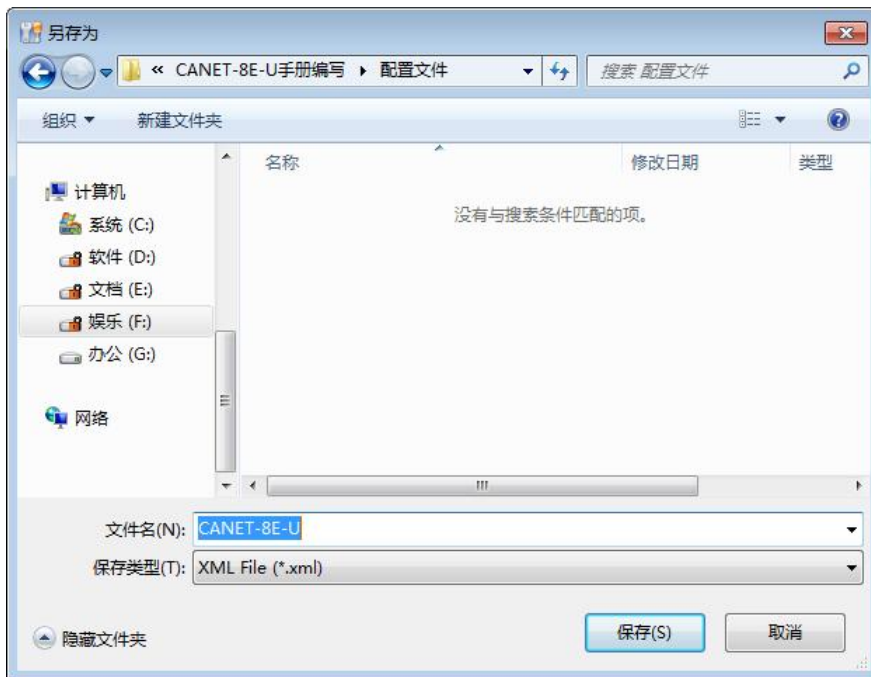
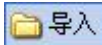

Figure 6.10 Saving device configurations

6.5.2 Restoring Settings

Click . In the "Open" dialog box, select the saved device configuration file,

and click the [Open] button. The ZNetCom software imports the settings saved in the file.

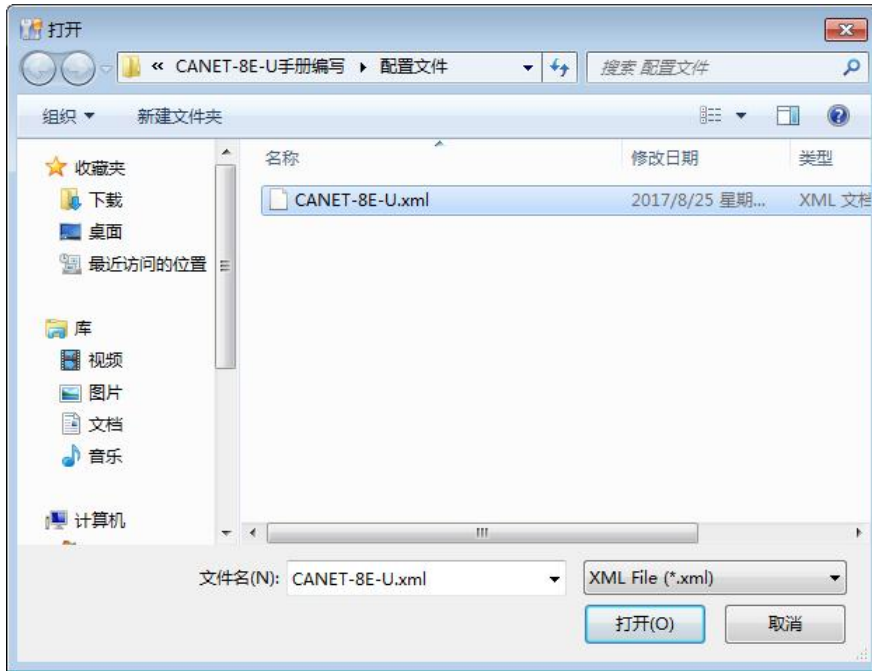

Figure 6.11 Opening device configurations

6.6 Upgrading Firmware

CANET series devices support local firmware upgrade. When you upgrade the CANET device by using the ZNetCom software, the PC and the CANET device must be on the same network segment (refer to 5.3 PC and device network segment detection). The firmware upgrade procedure is as follows:

- In the device list column of ZNetCom software, select the device to be upgraded in the list item, and right-click the mouse. The menu items appear, as shown in Figure 6.12.

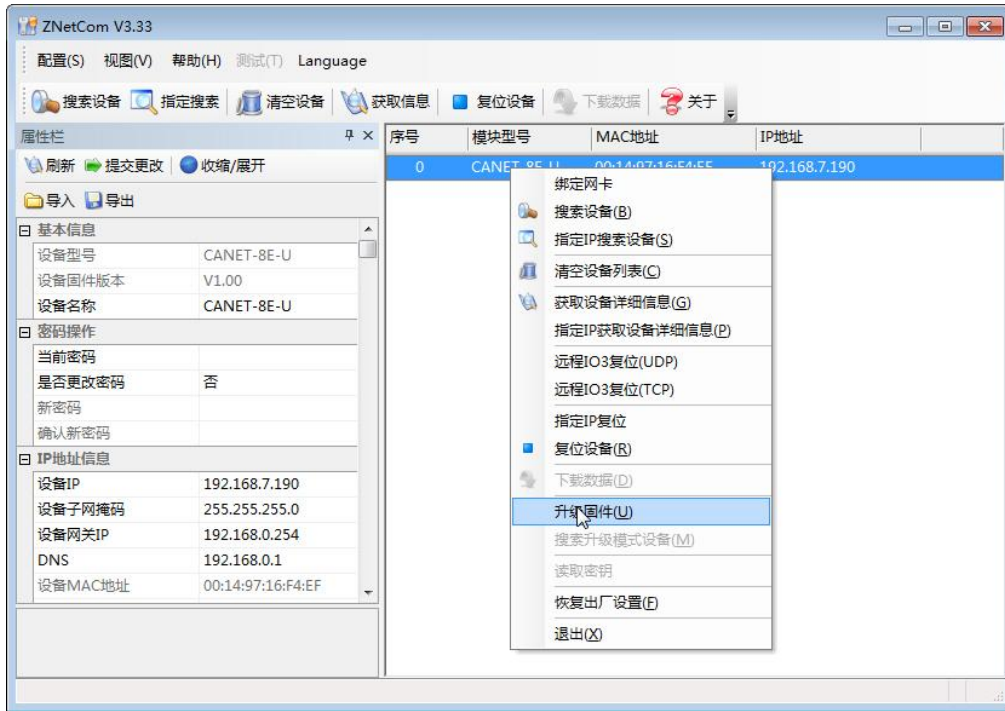
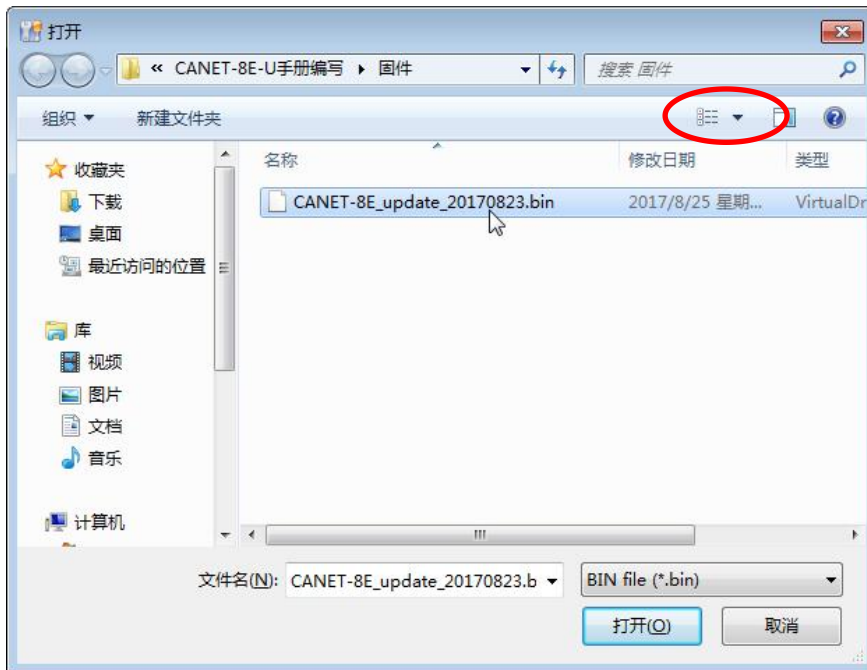

Figure 6.12 Firmware Upgrade menu

Click [Upgrade Firmware]. On the firmware upgrade interface shown in Figure 6.13, enter the password (the default password is 88888), select the upgrade file, and click "Open".



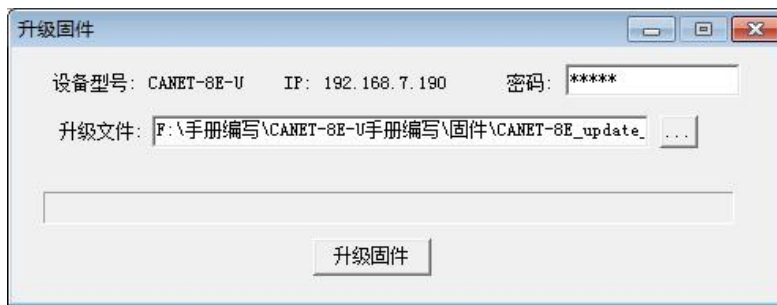

Figure 6.13 Firmware upgrade interface

Click **升级固件**. The device starts firmware upgrade.

After about 1 minute, the firmware can be upgraded, as shown in Figure 6.14. Wait about 30 seconds until the system is initialized and starts.

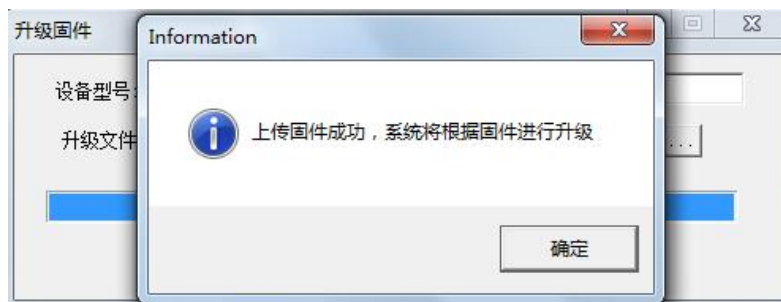

Figure 6.14 Firmware upgrade completed

7. Providing the Secondary Development Guidance for the Host Computer

Use one of the following methods for the CANET-8E-U host computer (communication) development:

- Application programming interface functions using CAN cards (both 32-bit and 64-bit).
- Directly use the standard TCP programming interface API to establish a Socket connection.

The difference between these two methods is mainly reflected in the data format received by the host computer. At the same time, when a frame ID is 0 and the data is a standard data frame of 00 01 02 03 04 05 06 07. The display difference between the two is as follows:

序号	传输方向	时间标识	帧ID	帧格式	帧类型	数据长度	数据(HEX)
00000000	接收	无	0x00000000	数据帧	标准帧	0x08	00 01 02 03 04 05 06 07

Figure 7.1 Data format displayed by the host computer when the CAN card interface function is used

If the first method is used, the CAN card interface functions will be listed in the format of ID, data, etc., as shown in Figure 7.1.

```
08 00 00 00 00 00 01 02 03 04 05 06 07
```

Figure 7.2 Data format displayed by the host computer when using the Socket function

If the second method is used, the received data format is shown in Figure 7.2. For the same data, the Socket link will only display 13 bytes of data (for the specific meaning, see Section 8.1); follow the rules to write a program for analysis.

If you choose the first method, ZLG Electronics provides 32-bit and 64-bit CAN card application programming interface functions to support most mainstream development environments; it provides demonstration codes for users to learn and develop. For the development process of this method, see Sections 7.1 and 7.2.

7.1 Preliminary Preparation for CAN Card Interface Function Development

If you are going to start designing your own PC software, you are advised to prepare the following documentation first. The documentation can be obtained from the product documentation download page at ZLG Electronics' official website:

- CAN Test software and Interface Function User Manual;
- Secondary development interface function library for the CAN interface card;
- CANET-8E-U host computer routine.

The *CAN Test Software and Interface Function User Manual* mainly introduces CAN card type definition, function library data structure definition, and interface library function usage and parameters.

The CAN interface card secondary development interface function library provides 32-bit and 64-bit versions, including a kernelDlls folder and a ControlCAN.dll file.

The CANET-8E-U upper computer routine provides related demonstration codes, which helps you learn the calling process of interface functions.

7.2 Interface Library Function Usage Process

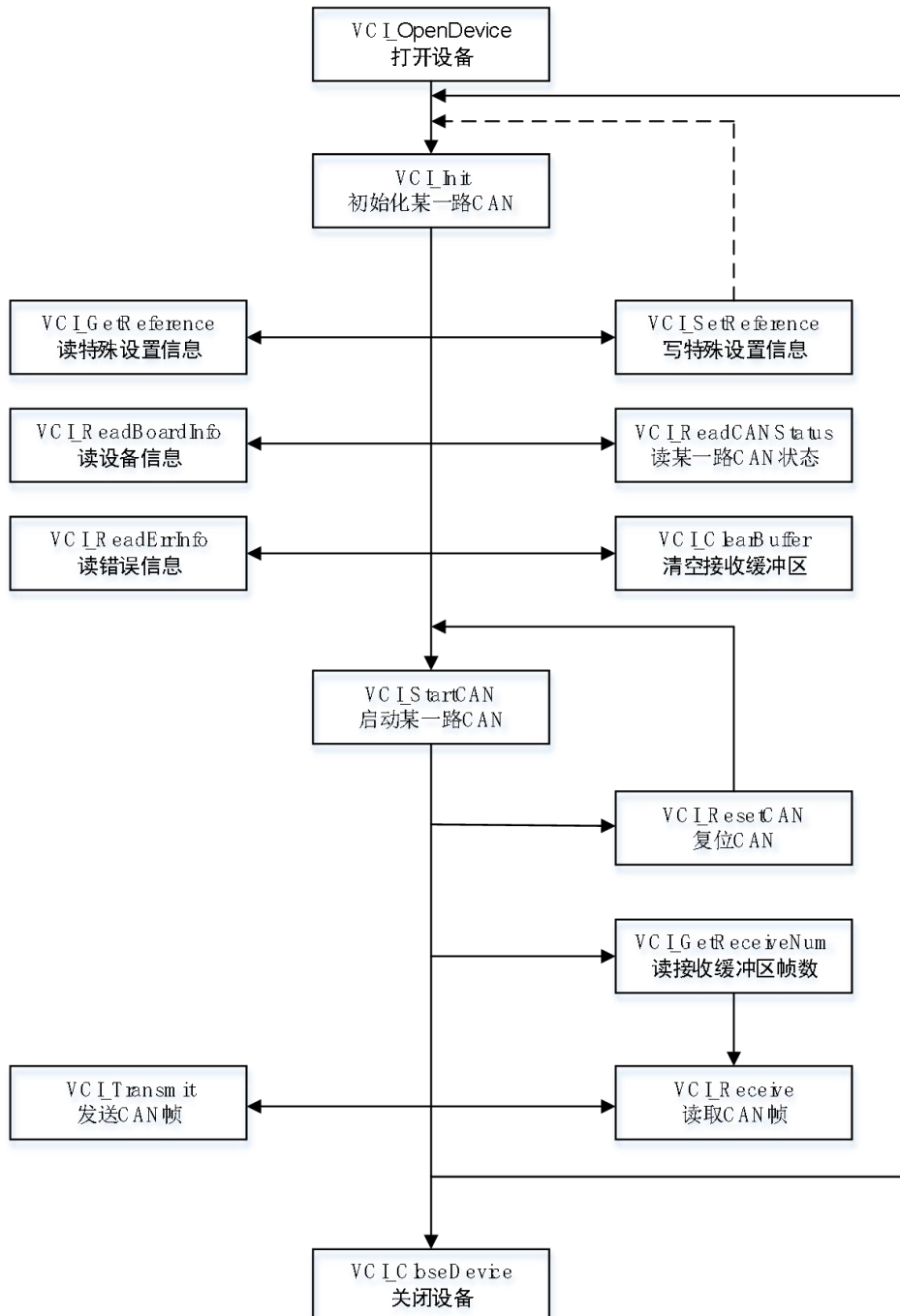

8. Appendix

8.1 CANET-8E-U Working Port Data Conversion Format

Each TCP or UDP frame contains
(最多50, 最少1个CAN帧)

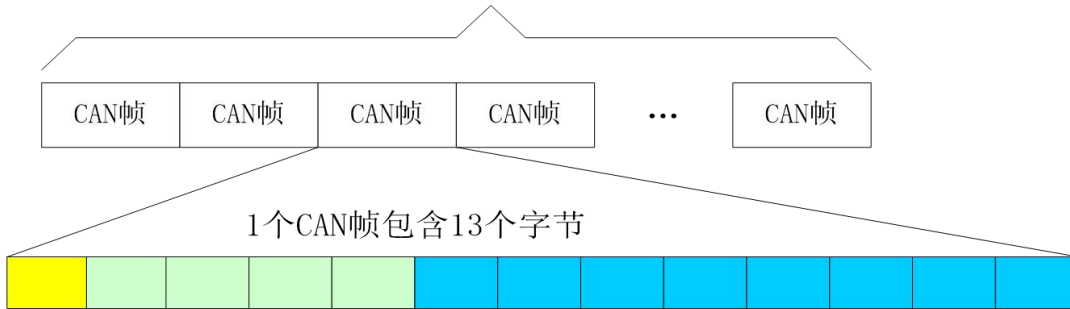

帧信息: 长度1个字节, 用于标识该CAN帧的一些信息, 如类型、长度等



FF: 标准帧和扩展帧的标识, 1为扩展帧, 0为标准帧。
RTR: 远程帧和数据帧的标识, 1为远程帧, 0为数据帧。
保留值为0, 不可写入1。
D3~D0 : 标识该CAN帧的数据长度。

帧ID: 长度4个字节, 标准帧有效位是11位, 扩展帧有效位是29位。



如上为扩展帧ID号
0x12345678h 的表示方式

如上为标准帧ID号
0x3FFh 的表示方式

帧数据: 长度8个字节, 有效长度由帧信息的D3~D0的值决定。

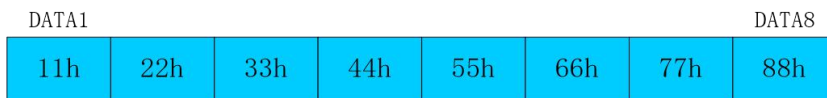

如上为8个字节有效数据的表示方式

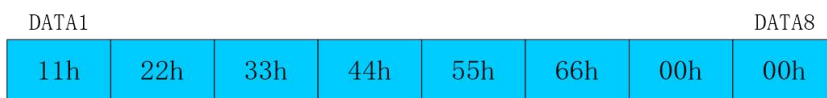

如上为6个字节有效数据的表示方式

以下例子是一个扩展数据帧，ID为0x12345678，包含8个字节数据（11h, 22h, 33h, 44h, 55h, 66h, 77h, 88h）的帧的表示方式

88h	12h	34h	56h	78h	11h	22h	33h	44h	55h	66h	77h	88h
-----	-----	-----	-----	-----	-----	-----	-----	-----	-----	-----	-----	-----

以下例子是一个标准数据帧，ID为0x3ff，包含6个字节数据（11h, 22h, 33h, 44h, 55h, 66h）的帧的表示方式

06h	00h	00h	03h	FFh	11h	22h	33h	44h	55h	66h	00h	00h
-----	-----	-----	-----	-----	-----	-----	-----	-----	-----	-----	-----	-----

When you send UDP frames on the PC, the number of CAN frames contained in each UDP frame cannot be greater than 50 frames! It is recommended that the sending speed of UDP frames should not exceed 400 packets per second. There is another condition. If the user has 400 packets of UDP frames per second, and each UDP frame contains 50 CAN frames, you can calculate that it is equivalent to 20,000 CAN frames per second. Even with a baud rate of 1,000 kbps, the CAN cannot send it so fast. Therefore, it is recommended that you should not send more than 400 UDP frames per second, and should not convert more than 4000 frames per second into CAN frames.

8.2 CANET-8E-U Data Conversion Format of TCP Notification Port in CAN Port State

某路CAN对应的TCP通知端口被连接后，如果此路CAN发生错误，通知端口将向主机定时发出状态警告，TCP包数据段格式如下：



 固定格式。包头AAh 00h, 包尾55h

 CMD 状态码

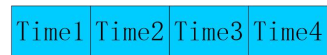
 Time1 Time2 Time3 Time4 错误计数(32bit)，高字节在前，即Time1为高字节

CMD value	Status meaning (both are CANET devices)	Time error count value	Notification period (seconds)
00h	Ethernet send buffer is about to overflow	0	2s
01h	Ethernet send buffer has overflowed	0	0.5s
02h	Ethernet receive buffer is about to overflow	0	2s
03h	Ethernet receive buffer has overflowed	0	0.5s
04h	The CAN controller sends an error alarm (send error counter > 96)	Number of occurrences	2s
05h	The CAN controller receives an error alarm (receive error counter > 96)	Number of occurrences	2s
06h	CAN controller transmit error passive (transmit error counter > 127)	Number of occurrences	2s
07h	CAN controller receive error passive (receive error counter > 127)	Number of occurrences	2s
08h	CAN controller receive overflow error (overload)	Number of occurrences	2s
09h	CAN controller bus off (bus off)	Number of occurrences	2s
0Ah	CAN controller arbitration loss (bus congestion)	Number of occurrences	2s
0Bh	CAN controller bus error (as long as there is an error)	Number of occurrences	2s
0Ch	Other errors	Number of occurrences	2s

9. Disclaimer

Based on the principle of providing better service for users, Guangzhou ZLG Electronics Co., Ltd. ("ZLG Electronics") will try to present detailed and accurate product information in this manual. However, due to the effectiveness of this manual within a particular period of time, ZLG Electronics does not guarantee the applicability of this document at any time. ZLG Electronics shall reserve the right to update this manual without prior notice. To get the latest version, please visit the official website of ZLG Electronics regularly or contact ZLG Electronics. Thank you!

Dreams come true with professionalism and dedication.

**Guangzhou ZLG
Electronics Co., Ltd.**

For more details, please visit www.zlg.cn
Welcome to call the national service hotline **400-888-4005**

